

# Chegg

## Q&A Authoring Guidelines

January 2025

# Table of Contents

- 01 Your Journey
- 02 Practice Site
- 03 Check My Structure (CMS)
- 04 Your Dashboard
- 05 Question Window
- 06 How To Skip Questions?
- 07 How To Attempt?
- 08 Solution Window
- 09 Chegg "Honor Code"
- 10 Quality Review
- 11 Other Points To Keep In Mind
- 12 Practices To Avoid
- 13 Payments & How To Contact Us?

# Your Journey

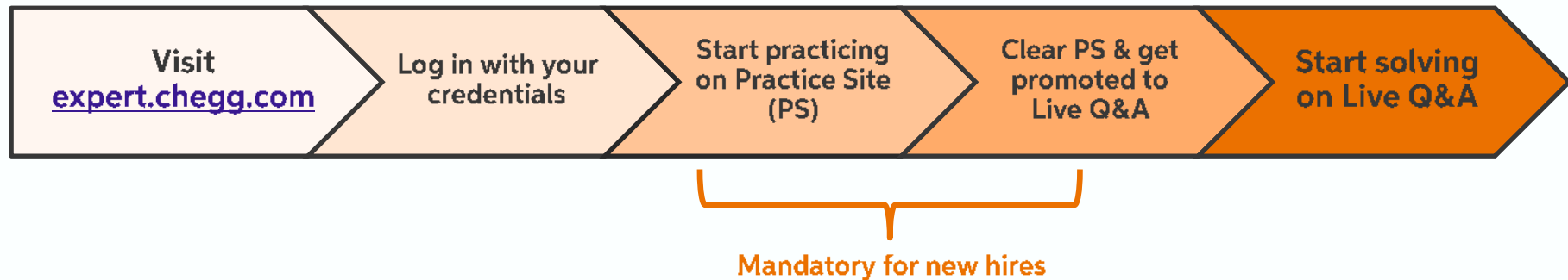

Your Chegg Q&A journey starts the day you get your Q&A authoring privileges.

**Practice Site (PS):** To enhance the authoring experience for newly hired experts, we have introduced the Practice Site on the Q&A dashboard.

- The Practice Site feature is mandatory only for newly hired experts. There are no changes in the Q&A dashboard for existing experts.
- You will be **paid** for all the valid solutions submitted in passed attempt on the Practice Site.

# Practice Site

## Promotion Criteria for Live Q&A

Particulars	Criteria
Solution count	3
Average QC score	$\geq 4.5$
Skip limit (per attempt)	100

### Follow these steps to start your journey as an expert:

1. Go to [expert.chegg.com](https://expert.chegg.com).
2. Sign in with your credentials.
3. You will be redirected to the home page.
4. Go through all the **training videos** and finish the mandatory training.
5. Click on 'Start practicing'.
6. Surface through the questions, start typing your solution, and provide a **step-by-step detailed explanation**. Please note that you can **skip a maximum of 100 questions per attempt**. If you try to skip more than that, your attempt will be marked as unsuccessful.
7. Once you fulfill the above-mentioned criteria i.e., submitting at least **3 solutions with an Avg QC score of  $\geq 4.5$** , you'll receive access to the Live Q&A within 4 days.
8. You will be **paid** for all the valid solutions submitted in passed attempts on the Practice Site. Payments will be made as per the terms and conditions.
9. No payment will be made for questions solved in the failed attempt(s).

# Check My Structure (CMS)

**Check My Structure** serves as a 24/7 guide to help author better-structured solutions.

The 'Check My Structure' feature on the authoring platform can be used by clicking the '**Check Structure**' button; it is always available while you create your solution.

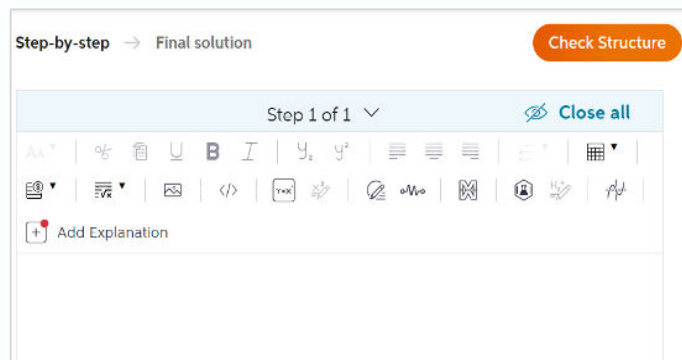

When you click the '**Submit your solution**' button, a pop-up with structuring recommendations will also appear as shown below:

The screenshot shows a pop-up window titled "Check my structure". It contains a table with the following data:

Requirement	Points	Mark as Not Applicable
You have 37 of 60 total points for a score of 62%. Please ensure your score is at least 75% to submit your answer.		
1. Steps in solution. Students prioritize answers with <b>two or more steps</b> over single-step answers.	10/10 points	
2. Required editor tools. Receive 5 points for each usage of a math tool or other editing tools.	5/10 points	
3. Words per step. We recommend <b>min 10 words per step</b> for comprehensive learning.	2/10 points	
4. Explanations. Steps with <b>explanations</b> help make learning easier.	10/10 points	
5. No images allowed. Images of content that can be created in Expert 2.0 are not permitted.	10/10 points	
6. Final answer word count. Final answers with <b>min 10 words</b> increase solution clarity.	0/10 points	

At the bottom of the pop-up, there is an orange button labeled "Improve and use editor tools".

**Note: You must achieve at least a 75% Check My Structure (CMS) score.**

# Your Live Q&A Dashboard

**Chegg** Home My Past Activities ▾

Guide Me Notifications

What would you like to do today?

Visit your previously submitted solution/s.

This section shows your performance stats.

My Stats Today ▾

**Q&A Authoring** NA Pricing 200 Q Limit

Students love reading clear, step-by-step solutions. Author well-explained solutions using our in-built editor.

CF Score: N/A | QC Score: 5.00 ⓘ

Start solving

Improve your Chegg rating to increase your authoring price multiplier and authoring limit.

Visit the question window.

**Q&A Authoring**

CF Score	N/A
Solved	0
Skipped	0

Ensure you follow the Q&A Authoring Guidelines to maintain a CF Score of 80% or more. For any help, please visit our [support page](#).

**User Guidelines**

Q&A Authoring

**Contact us**  
Reach out for any support or queries.

Support ticket unresolved? ⓘ

**Frequently Asked Questions**

Overall Q&A Authoring

My question got skipped automatically. How can I get the same question again? ▾

What happens if my account gets revoked? ▾

# Question Window

Click on **Start solving** to take you to the question.

You get 10 minutes to decide if you want to solve or skip/exit the question.

The screenshot shows the Chegg interface for a student question. At the top, there are navigation links for Home, Expert Q&A, and My solutions. A timer indicates 00:09:48 left. The question text asks for a portfolio of Call and Put options. A graph shows a piecewise linear function with a horizontal segment. Below the graph are three callouts: 'Click here to skip the question and move to the next one.' pointing to the 'Skip question' button, 'Click here to start solving the question.' pointing to the 'Start Solving' button, and 'Click here to exit.' pointing to the 'Exit' button. A help icon is also present.

**Student question** Time Left : 00:09:48

Suppose you plan to build a portfolio with Call and Put options in amounts of each that you must determine, giving the following payment pattern:

**Note:** If you do not decide in the allocated **10 minutes**, the question gets skipped automatically and a new question will appear on your screen.

Click here to skip the question and move to the next one. **Skip question**

Click here to start solving the question. **Start Solving**

Click here to exit. **Exit**

**?**

# How to Skip Questions?

You can skip a question whenever you want, provided you select the correct skip reason. You can choose the reason from the list below:

- **"I can solve, but the question..."** - Choose whether the question is difficult, lengthy, has multiple subparts, or has multiple questions.
- **"I cannot solve this question, because..."** - Choose whether the question is blurred, incomplete, requires external tools, does not belong to your subject, or you do not know the solution.
- **"This question violates authoring guidelines."** - Choose whether the question belongs to an exam/test/quiz, has a copyright/external URL, requires lab work, is spam, or has points/ marks/ grades.

### Why are you skipping this question?

I can solve, but the question:

I cannot solve this question, because:

This question violates authoring guidelines:



# How to attempt?

**Multiple Choice Questions (MCQs):** Provide the correct option, and a detailed explanation of why that option is correct and why the remaining aren't.  
Example:

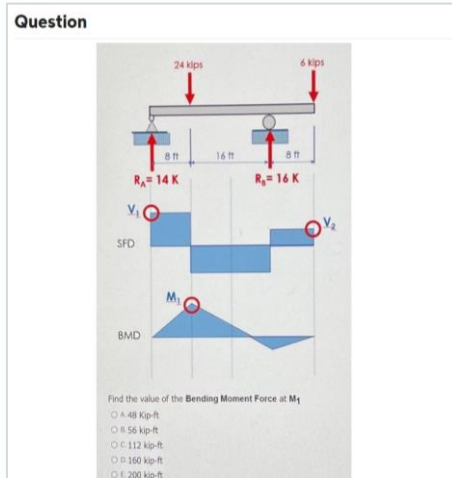

**Solution approach:** A detailed explanation for each option, i.e., which option is correct, why, and the reasoning for the incorrect options.

**Multiple Questions:** Solve all the questions, **unless** the student has asked for a specific question to be solved.  
Example:

## Questions

- 1.) What is respiratory system?
- 2.) How do plants make food?
- 3.) Explain diversity in living organisms.
- 4.) What are communicable diseases and how to control them?

**Solution approach:** Solve all the questions (as the student didn't specify which one among the 4 needs to be solved).

# How to attempt?

**Questions with sub-parts:** Solve all parts of multiple sub-part questions unless the student has specified to solve only certain sub-part/s. Example:

Write the MATLAB CODES for questions (1-5) and show the output, this problem must be solved in matlab. Only solve in MATLAB AND PROVIDE THE OUTPUT SCREENSHOTS

A digital communication link carries binary-coded words representing samples of an input signal-

$$x_c(t) = \cos(2000\pi t) + 3\cos(5000\pi t) + 5\cos(9000\pi t)$$

The link is operated at 24,000bits/second and each input signal is quantized into 4096 different voltage levels.

- 1) What is the Nyquist rate for this signal?
- 2) What is the sampling rate, sampling interval, folding frequency for this signal?
- 3) What is the discrete-time signal obtained after sampling? (Find out the simplest form)
- 4) Determine whether the discrete signal is periodic or not. Compute the fundamental period if the signal is periodic.
- 5) What is the analog signal  $y_a(t)$  that we can reconstruct from the samples if we use ideal interpolation?

**Solution approach:** Solve all the sub-parts of the question. Add the solution of all the sub-parts in your Final Solution section.

**Questions in non-English language:** Solve only when you know the language. If you are unable to understand or translate the language, skip the question under "**I can't solve this question because: >Question is incomplete**" and ask the student to upload the question in English.

Example:

二, 用“的”, “得”或“地”填空:

1. 我朋友把我房间扫 ( ) 真干净。
2. 桌子上 ( ) 书不是我的书。
3. 她绣花绣 ( ) 非常漂亮。
4. 她开心 ( ) 说笑。
5. 清清 ( ) 河水不断的流着。

**Solution approach:** Solve only when you know the language and submit the solution in English Language only.

# Solution Window

- Click on the 'Start Solving' button on the question window. It will take you to the solution window. On the left, you will see the question, and on the right, you will see the solution window.
- You have exactly 120 minutes to solve the question. If you need an extra 30 minutes, take advantage of the bonus time that will be offered at 110 minutes into the 120-minute session. If the whole solution is not provided within the allocated 120 minutes, the question gets skipped immediately. Compensation is not provided for such solutions.
- In case you encounter difficulty while solving a question, you always have the option to skip it and proceed further.

The screenshot displays the Chegg Solution Window interface. On the left, the 'Student question' section contains a problem statement and eight numbered questions. On the right, the 'Tag the question' section includes fields for 'Subject' (Finance) and 'Sub-subject' (Search And Select). At the bottom, there are buttons for 'Skip question', 'Exit', 'Back', 'Next', and 'Submit your solution'.

**Student question** Time Left: 01:59:18

We are evaluating a project that costs \$799,000, has a life of 7 years, and has no salvage value. Assume that depreciation is straight-line to zero over the life of the project. Sales are projected at 158,000 units per year. Price per unit is \$42, variable cost per unit is \$24, and fixed costs are \$809,387 per year. The tax rate is 21 percent, and we require a return of 17 percent on this project.

1. Calculate the accounting break-even point.
2. What is the degree of operating leverage at the accounting break-even point?
3. Calculate the base-case cash flow.
4. Calculate the NPV.
5. What is the sensitivity of NPV to changes in the quantity sold?
6. What your answer tells you about a 500-unit decrease in the quantity sold?
7. What is the sensitivity of OCF to changes in the variable cost figure?
8. How much will OCF change if variable costs decrease by \$1?

**Tag the question** → Step-by-step → Final solution

Subject  
Finance

Sub-subject  
Search And Select

**Skip question** **Exit** **Back** **Next** **Submit your solution**

The solution flow is divided into **three main steps**:-

## 1. Tagging

- Select the sub-subject and the topic.
- Click 'Next' for step-by-step solution.
- Make sure to tag the question correctly.

The screenshot shows a tagging interface with the following elements:

- Navigation: Tag the question → Step-by-step → Final solution
- Subject: Advanced Physics
- Sub-subject: Applied Physics (selected from a dropdown menu)

## 2. Step-by-Step

- Every solution begins with a default step, allowing you to add further steps by clicking 'Add another step' at the editor's bottom.
- Promote comprehensive student learning through step-by-step solutions.
- Enhance quality by including explanations within the steps as required.

The screenshot shows a step-by-step solution editor with the following elements:

- Navigation: Step-by-step → Final solution
- Check Structure button (top right)
- Step list:
  - Step 1 of 3 ^ Open all
  - Step 2 of 3 ^ Open all
  - Step 3 of 3 v Close all
- Rich text editor toolbar with options like Bold, Italic, Underline, Text Color, Background Color, Bulleted List, Numbered List, Indent, Outdent, Link, Unlink, and a Delete step button.
- Content area: Functions of Financial Management
  - 1. **Estimation of capital requirements:** A finance manager has to make estimation with regard to the capital requirements of the company. This will depend upon expected costs and profits and future programs and policies of a concern. Estimations have to be made in an adequate manner which increases earning capacity of the enterprise.
  - 2. **Determination of capital composition:** Once the estimation has been made, the capital structure had to be decided. This involves short-term and long-term debt-equity analysis. This will depend upon the proportion of equity capital a company is possessing and additional funds which have to be raised from outside parties.
- Add another step button (bottom center)
- Navigation buttons: Back, Next, Submit your solution (bottom right)
- Help icon (bottom right)

### 3. Final Solution

After completing the step-by-step solution, add 'Final Solution'.

- **Final Solution:** Provide a concise and clear summary of the solution in easy-to-understand language.
- **Referencing Content:** If the final solution includes content that's already in the steps (e.g., tables or journal entries), then a simple sentence is enough, pointing to the relevant step.
- **Preview and Submission:** Preview the completed solution by clicking 'Preview your solution' to see how it will appear to students. Once finalized, submit the solution by clicking "Submit your solution".

**Final Solution**

Final Solution

AA\* | % |   |  |  | y, y' | [bulleted list] | [numbered list] | [table] | [link] | [unlink] | [code] | [math] | [media] | [undo] | [redo] | [clear step]

(a) The heat transfer to the working fluid in the steam generator is 3,158.53 kJ/kg.

(b) The thermal efficiency of the cycle is 34.46%.

(c) The heat transfer from the working fluid passing through the condenser to the cooling water is 2,070.18 kJ/kg.

# Solution Formatting/Alignment

## Wrong Formatting/Alignment

**Step 2/3**

The term "linear moment" is not represented with a variable and equations are written in the same line.

Before collision total linear momentum in the direction of ball =  $7.9 \times 8.3 = 65.57 \text{ kgm/s}$

After collision total linear momentum in the direction of ball  
=  $7.9 \times 6.5 \cos 1.70^\circ + 0.826 \times v \times \cos 18.5^\circ \text{ kgm/s}$

Where v is velocity of balling pin.

**X**

**Step 3/3**

The format of units should be in the equation editor instead of the text.

## Correct Formatting/Alignment

Calculate the total linear momentum in the direction of ball before collision.

$P_1 = 7.9 \times 8.3$   
 $= 65.57 \text{ kg} \cdot \text{m/s}$

The term "linear moment" is represented with a variable and units are also written in the proper format.

Write the equation for total linear momentum in the direction of ball after collision.

$P_2 = (7.9 \times 6.5 \cos 1.7^\circ) + (0.826 \times v \times \cos 18.5^\circ)$   
 $= 51.32739 + 0.7833v$

The equation is clearly written and simplified.



# Chegg “Honor Code”

Experts help students with the toughest questions while maintaining the highest standards in academic work. In doing so, Experts **must not** participate in aiding **academic dishonesty**.

As an Expert, you must adhere to our “**Honor Code**” to ensure you can continue working with us. **Any violation of our Honor Code would result in revocation of your Expert privileges.**

*Note: Experts should not subscribe to a student account. If found, both student and expert accounts will be terminated, and any balance payment or student subscription amount will be forfeited.*

# Honor Code: Dealing with

## – Examination/Test Questions, Activity-Based Questions

**Do not solve** questions that include terms such as "Final Exam," "Test," "Exam," or "Quiz" without specific dates or dates related to current and future years. If you come across such questions:

- Skip them under **"This question violates authoring guidelines: > Exam/Test/Quiz"** as we do not support any kind of cheating/academic dishonesty.

**Do not solve** questions that require you to perform an activity or experiment to arrive at the final solution.

- Skip them under **"This question violates authoring guidelines: > Requires Lab Work"**

60. The polymer shown is approved by the FDA for intravenous use because the hydrolysis products (smaller molecules) under normal physiological conditions result in the formation of two monomers that are easily handled by the body. It is an example of a Green polymer. Which monomers would be formed on hydrolysis of this polymer?

(A) HO-CH2-CH2-OH and HO-C(=O)-CH2-OH  
(B) H-C(=O)-CH2-OH and H-C(=O)-CH2-OH  
(C) HO-CH2-CH2-OH and HO-C(=O)-CH2-OH  
(D) H-C(=O)-CH2-OH and HO-CH2-CH2-OH

61. Which is most basic?

(A) C1=CN=C1 (B) C1=CC=C(N)C=C1  
(C) C1=CN=C1 (D) C1=CC=CC=C1N

62. How does water function in step 2 of this reaction?

(A) as an oxidizing medium (B) as a nucleophile  
(C) as a base (D) as an acid

63. Which is incorporated as the carbohydrate of the DNA polymer?

(A) HOCH2-CH(OH)-CH2-OH (B) HOCH2-CH(OH)-CH(OH)-CH2-OH  
(C) HOCH2-CH(OH)-CH(OH)-CH2-OH (D) HOCH2-CH(OH)-CH(OH)-CH2-OH

**X Exam Question**

Module 6 Virtual Lab: Functional Group Scavenger Hunt

Name: \_\_\_\_\_

Instructions: In this activity you'll get practice identifying and drawing aldehydes, ketones, and alcohols. Remember if you'd like to visualize things you can use [www.molbase.org](http://www.molbase.org)! Fill in each row of the table with the missing pieces of information.

Condensed Formula	Skeletal Structure	Functional Group(s)	Compound Type (alcohol, aldehyde, or ketone)	Alcohol Class (Primary, Secondary, or Tertiary - not an alcohol leave blank)
<chem>CH3CH2OH</chem>				
<chem>CH2O</chem>				
<chem>CH3CHO</chem>				

**X Activity Based Question**

**Note:** Questions belonging to any previous year's examination, quiz, or test are not spammed and can be attempted.

Questions with terms like "Exam Review", "Practice Test", and "Practice Exam" are not abusive and can be attempted.



# Honor Code: Dealing with Examination/Copyrighted Questions

**Do not solve** questions with logos/watermarks of institutions, e.g., “Ryerson University”, “Exams Institute”, “Div. Ched”, “ACS”, or “Sapling Learning”, as these are examination / copyrighted questions.

You must skip these under the “**This question violates authoring guidelines: > Copyright/External URL**” reason.

The concept of present value relates to the idea that

- The discount rate is always higher when you invest now than in the future
- The discount rate is always higher when you invest in the future than
- The money you have now is worth less today than an identical amount you would receive in the future
- The money you have now is worth more today than an identical amount you would receive in the future

The formula for calculating future value (FV) is

- $FV = PV/(1+r)^n$
- $FV = PV/(1+r)*n$
- $FV = PV \times (1+r)^n$
- $FV = PV \times (1+r)*n$

**X**

Find the value of  $I_1$ ,  $I_2$  and  $I_3$ .

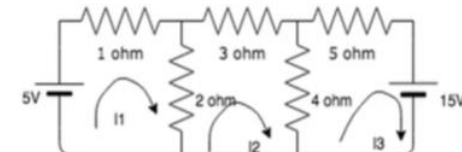

- a) -0.566A, 1.29A, -1.91A
- b) -1.29A, -0.566A, 1.91A
- c) 1.29A, -0.566A, -1.91A
- d) 1.91A, 0.566A, 1.29A

© 2000 - 2026 John Wiley & Sons, Inc. All Rights Reserved. A Division of

**X**

# Honor Code: Dealing with

## – Third-Party Links

**Do not solve** questions containing external links.

-You must skip such questions under the “**This question violates authoring guidelines: > Copyright/External URL**” reason.

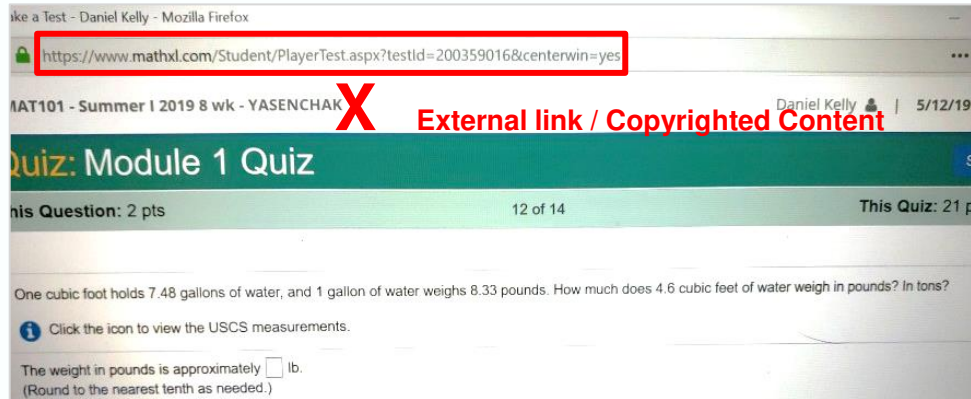

ike a Test - Daniel Kelly - Mozilla Firefox

<https://www.mathxl.com/Student/PlayerTest.aspx?testId=200359016&centerwin=yes>

**X External link / Copyrighted Content**

MAT101 - Summer I 2019 8 wk - YASENCHAK Daniel Kelly | 5/12/19

**Quiz: Module 1 Quiz**

This Question: 2 pts 12 of 14 This Quiz: 21 p

One cubic foot holds 7.48 gallons of water, and 1 gallon of water weighs 8.33 pounds. How much does 4.6 cubic feet of water weigh in pounds? In tons?

Click the icon to view the USCS measurements.

The weight in pounds is approximately  lb.  
(Round to the nearest tenth as needed.)

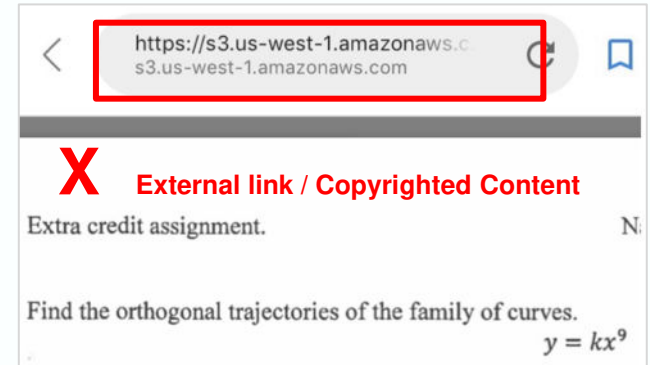

<https://s3.us-west-1.amazonaws.com/s3.us-west-1.amazonaws.com>

**X External link / Copyrighted Content**

Extra credit assignment.

Find the orthogonal trajectories of the family of curves.

$$y = kx^9$$

# Honor Code: Dealing with

## – Proctored Exam Questions

Proctored exams are timed, graded exams that a candidate takes on a computer while proctoring software identifies the candidate and supervises the candidate's computer activity by capturing the computer screen, to ensure that the exam is being taken in accordance with the academic integrity rules of the university and professor.

**Do not solve** questions that contain images/terms from proctoring software, such as “Proctorio is sharing your screen”, “Honorlock is sharing your screen”, “Requires Respondus LockDown Browser”, or “ProctorU is sharing your screen”.

You must skip such questions under the **“This question violates authoring guidelines: > Spam”** reason.

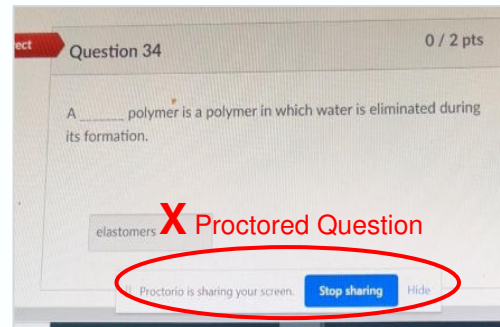
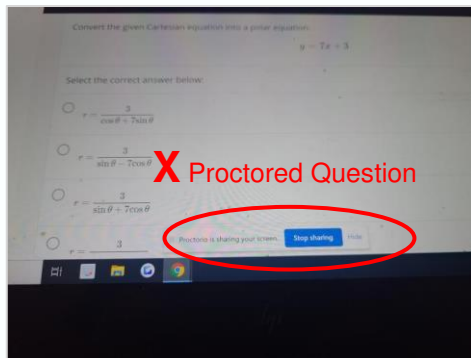
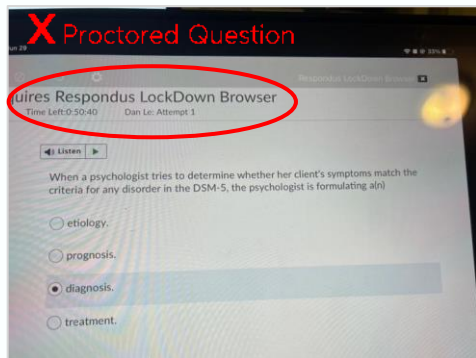

# Honor Code: Dealing with

- Questions having points/marks/grades
- Opinion/ Perception-Based Questions, Essay Questions

## Do not solve :

- Questions that have points/marks/grades except for questions having a tag  Safe to solve ⓘ
- You must skip all such questions under the “**This question violates authoring guidelines: > Points/Marks/Grades**” reason.

## Do not solve :

- Questions that explicitly ask for your opinion or personal input.
- Questions that explicitly ask for an essay or “essay writing”.
- You must skip all such questions under the “**This question violates authoring guidelines: > Spam**” reason.

Directions: Read and answer each question below carefully in not less than 5 sentences. (30 points)

1. If given the chance to design your own walking staff, what feature would you add to make it useful on the trail? (10 points) **X**
2. What are the safety tips you should consider when crossing a fast-flowing river? Provide at least 5 safety tips and briefly explain each. (10 points)
3. Which of the alternative rafts do you think is the safest when crossing a fast-flowing river? Explain your answer. (5 points)
4. Why is swimming important for survival? (5 points)

### Question

Q1. Give **your own example** illustrating two of the following economic principles. **X**

- (a) How much is a decision at the margin.
- (b) People usually respond to incentives, exploiting opportunities to make themselves better off.

### Question

**Essay Topic: X**

- What is corruption? How does it impact an economy?

Please make sure you mention your sources in the essay.

## Honor Code: Plagiarism

Copying content from any source, whether fully or partially, is considered plagiarism. At Chegg, we follow a **zero-tolerance policy** against plagiarism.

### DO NOT:

- Copy/paste solutions from any third-party sources.
- Copy/paste solutions from chegg.com.
- Copy/paste screenshots or photos of any work that isn't yours.
- Provide any links to external sources / websites / cloud as part of your solution.
- Quote parts of someone else's work even while giving them credit.

### Note:

If you have solved a similar question before, please take the time to review and revise your solution for every new question.

# Quality Review

Quality reviews are feedback given on your solutions by our quality team so that you can improve your overall authoring quality for students' better learning experience.

Your solutions are reviewed by our quality team mainly based on **6 parameters: Relevancy, Completeness, Accuracy, Clarity, Structure, and Voice.**

To check your Quality Reviews, go to the 'My Solutions' tab.

You will find:

- **Chegg Rating** – Feedback shared by the Chegg Quality team.
- **Student Rating** – Feedback shared by the students.

The badge under 'Chegg Rating' indicates that your quality review for that solution is done.

- **Green** means “satisfactory”
- **Yellow** means “neutral”
- **Red** means “unsatisfactory”

Please note: You will **not be paid** for solutions that receive a “Red Badge” in the quality review.

The screenshot shows the Chegg 'My Solutions' interface. On the left, a list of questions is displayed, each with a 'Chegg Rated' badge. The main content area shows a 'Student Question' about electrical circuits, including a circuit diagram. Below the question, the 'Chegg Rating' is shown as 2.5 stars, with a 'Not good' badge. A red box explains that the solution failed to meet accuracy standards. The rating breakdown is as follows:

Parameter	Rating
Relevancy	★★★★☆
Completeness	★★★★☆
Accuracy	★☆☆☆☆
Clarity	Not Available
Structure	Not Available
Voice	Not Available

# Definition of Parameters

Solutions are reviewed by our quality team mainly based on **6 parameters: Relevancy, Completeness, Accuracy, Clarity, Structure, and Voice.**

**Relevancy:** This indicates how closely a solution aligns with the question asked. It evaluates whether the solution addresses the core aspects of the question and provides appropriate information.

**Completeness:** This indicates how thoroughly the solution addresses various asks in the question. It evaluates whether the solution has all essential information like calculations, diagrams, procedural steps, & explanatory statements in the solution.

**Accuracy:** It refers to how correct the provided solution is for the given question/s. This evaluates the correctness of the information/concept/method followed in the solution.

**Clarity:** Clarity refers to how easily the solution can be understood by the student. This evaluates the language complexity, readability, and redundancy of a solution.



**Structure:** Structure refers to how the solution is organized and presented in relation to the requirements of the question. This evaluates the necessity of steps and their effectiveness in helping the student grasp how to arrive at the solution.

**Voice:** This refers to the language and tone of the solution. This primarily evaluates whether a solution sounds human or overly non-human (bot-like).

# Other Points to Keep in Mind

The following questions can be attempted:

## Questions with

1. This tag:  **Safe to solve** 
2. Terms like Homework/Assignment/Experiment/Lab with or without points/marks from past academic periods/years
3. Terms like Exam Review/Quiz Review/Test Review
4. Terms like Graded assignment/assessment with past date
5. Logos of Laptops/Mobiles visible (like Dell, Apple, etc.)
6. CamScanner/any other image scanner logo
7. Practice/Sample + Test/Quiz/Exam mentioned
8. "Spring"/"Fall" or "F" for any previous year
9. "Exam/Test/Quiz" from past academic periods/years
10. Terms like Practice assessments and assessments from study guides

The following questions should be marked under “ This question violates authoring guidelines: > (Correct Reason) ” :

## Questions with

1. Homework/Assignment/Experiment/Lab with points/marks/grades mentioned.
2. Exam/Test/Quiz mentioned having current/future/no-academic periods/years.
3. Points/marks/grades mentioned having current/future/non-academic periods/years.
4. Graded assignment/assessment questions with due dates.
5. External Website URL (even partially visible URL).
6. Company Name/Logo/Copyright/External Reference to book/website.
7. "Spring"/"Fall" or "F" with or without points/marks for the current/future/no-academic periods/years.
8. Take Home Exam/Take Home Test/Take Home Quiz with current /future dates.
9. Specific instructions to take “no outside help”.
10. Unethical intent. e.g., Questions requiring web scraping in the solution.



# Practices to Avoid

## Avoid prohibited behaviors, including these areas:

1. **Illegal:** Defamatory, libelous, copyright, privacy, patent, trademark, or contract rights violations.
2. **Violent:** Abusive, harmful, harassing, threatening.
3. **Inappropriate:** Sex, indecency, bodily function, obscenities, death/trauma/grief, socially offensive topics.
4. **Prejudiced:** Bigotry, racism, xenophobia, sexism, ageist, disability, religious discrimination.
5. **Malicious:** Security threats, exploitative.
6. **Fraudulent:** Commercial activities, contests, sweepstakes, unsolicited advertising, spam.
7. **Misappropriating:** Modifying, copying, distributing, downloading, scraping, or transmitting content.

## Avoid:

1. Submitting solutions containing **AI-generated content**. Doing so would result in appropriate penalizations.
2. Asking students for feedback (**upvote/like/rating**) in the solutions.
3. Use of **improper language/profanity** on Chegg Q&A platform.
4. Sharing/asking for **personal details**.
5. Skipping questions using **incorrect skip reason**.
6. **Blaming/arguing** with student.
7. Submitting **incomplete/incorrect/direct** solutions.
8. Posting **irrelevant comments/suggestions**.
9. Intentionally distributing the **wrong** solution.
10. Submitting hard to read or **illegible solutions**.
11. **Posting offsite requests** - All interactions between students and experts must occur via Q&A platform. If students are requesting offsite help, please flag this behavior as abusive/spam.
12. Pasting **questions in the solution window**.
13. Solving **blank questions**.
14. Solving **incomplete questions**.

# Payments

Payment for valid solutions submitted on Live Q&A during a month is processed in the following month.

## Terms of our payment policy:

- You are paid only for correct solutions that conform to Q&A solution guidelines.
- You must submit your OWN PAN, AADHAAR and bank details (jointly-held bank accounts are prohibited).
- In line with Income Tax guidelines, Chegg is required to deduct applicable TDS on all payments made to Experts who have submitted their PAN card details. In such a case, you will be provided with a Form-16A mentioning the deduction.
- If payment is not processed in a particular month due to missing/incorrect bank details, they will be processed in next month's payment cycle only if the required details are provided in time.
- Any misuse of authoring privileges will lead to immediate account revocation and forfeiture of any due payments.

# How to Contact Us?

In case of any query, feel free to contact us through any of the following modes:

- Visit our **self-help** section at <https://qnasupport.cheggindia.com/portal/en/kb/expert-support>
- Submit a **support ticket** at <https://qnasupport.cheggindia.com/portal/en/newticket>

# Thank You